

STORMCHAMBER™

INSTALLATION BROCHURE

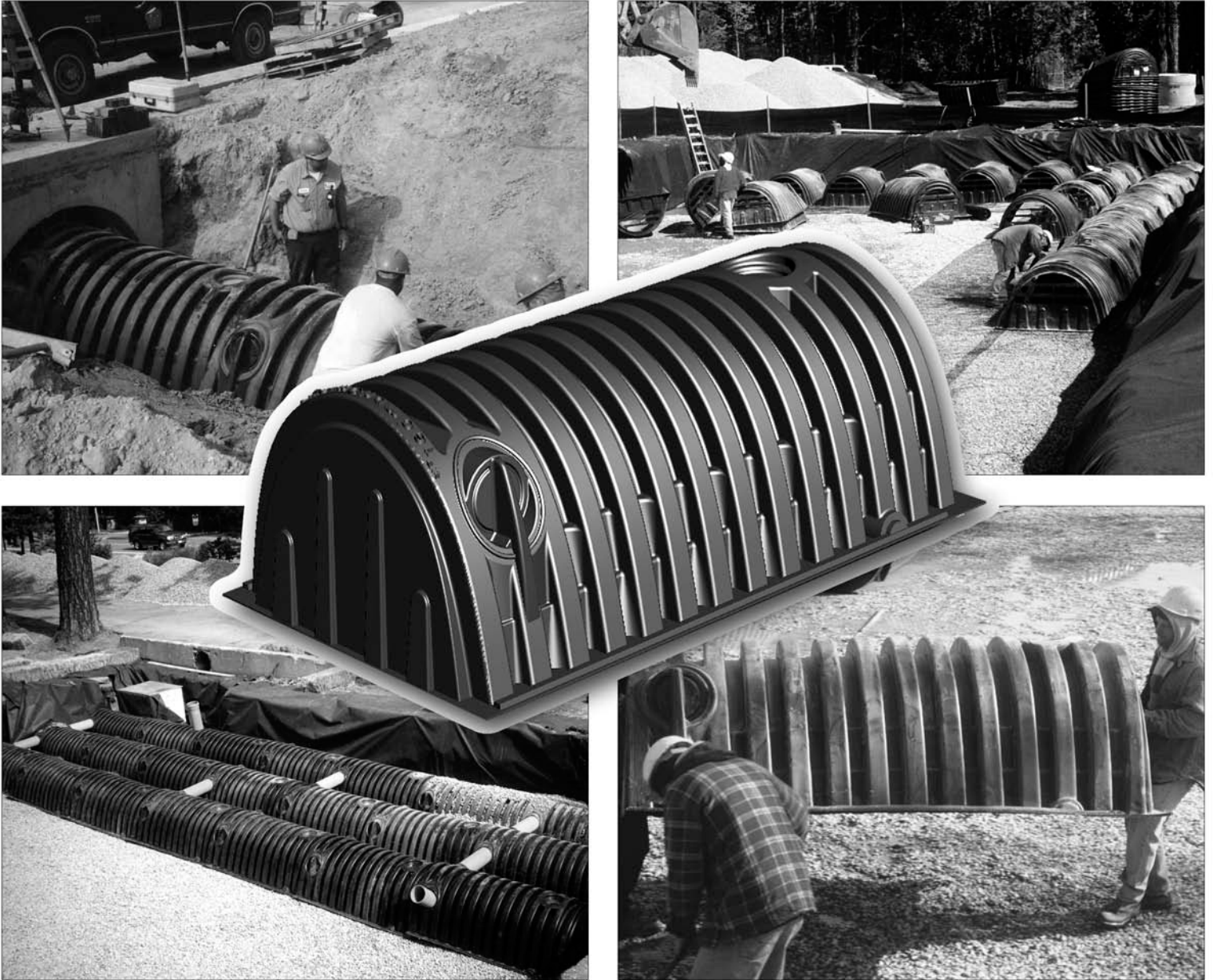

STORMWATER MANAGEMENT BROUGHT TO YOU BY HYDROLOGIC SOLUTIONS

BEFORE YOUR STORMCHAMBERS™ ARRIVE



1. StormChambers™ will arrive either on a flat bed trailer or in an enclosed van. If in an enclosed van, we will try our best to have the driver load the pallets at the tail of the van. However, be prepared with a long chain, metal cable, or strong rope or straps to drag a pallet from the nose of the van. A forklift is the easiest way to unload pallets of StormChambers™.
2. A full pallet of StormChambers™ will weigh approximately 1,700 pounds, will be about 5' wide, 8.5' long, and approximately 8.5' high.
3. **MATERIALS NEEDED**
 1. Wire cutters to remove the metal bands that secure the StormChambers™ to their pallets.
 2. Two 6'-10' lengths of 2x4 studs to use as levers to separate the palletized StormChambers™.
 3. 3" drywall screws to close in the bases of the StormChambers™ until the stone is placed around them.
 4. Light weight stabilization netting to go under the StormChambers™ to prevent movement of stone – shipped with the StormChambers™.
 5. Heavy weight stabilization netting, to be centered below each inspection/clean out riser to prevent removal of stone and soil when vacuum – cleaned with a vacuum truck. Also to be placed under each StormChamber™ to receive storm water from storm drain inlet pipes, to function as a "splash pan" to prevent erosion of underlying stone and soil – shipped with the StormChambers™.
 6. 1"-2" crushed, washed, hard stone for the trench base and to backfill around the StormChambers™.
7. 4 ounce non – woven filter fabric to be used at the interface between the stone and soil backfill and to cover trench side walls. Use Mirafi 140N, Mirafi 140NC, Synthetic Industries 401, or AMOCO 4545 or 4535 filter fabric.
8. 4' sections of 8" (unless otherwise specified), smooth walled Schedule 40 or SDR 35 or equivalent pipe for the interconnections between rows of StormChambers™ (check plans for number and location of interconnections).
9. Unless otherwise specified, 10" smooth walled Schedule 40 or SDR 35 or equivalent pipe for inspection/clean out risers (check plans for number and location of risers).
10. Three small angle irons and 0.5" screws for each inspection/clean out riser to support riser onto top portals of StormChambers™.
11. Cleanout caps or tops for inspection/clean out risers.
12. Unless otherwise specified, one casting for each inspection/clean out riser in pavement (East Jordan V – 8450 or equivalent).
13. Unless otherwise specified, concrete and related materials to form 6' x 9' reinforced pads to hold castings for inspection/clean out risers.

EQUIPMENT NEEDED

1. Forklift or other type of equipment to unload StormChambers™ (see above).
2. Excavator to dig the trench from the sides and to place stone and soil backfill.
3. Two battery or power operated screw guns to connect bases of overlapping StormChambers™.
4. Saws – All, router bit on a drill, or key hole saw to cut open side and top portals in StormChambers™.
5. Light weight, tracked dozer, not exceeding 1,100 lbs/sf to grade backfill.
6. Hand – operated compactor, small roller, or tracked vehicle for fill compaction. Tracked vehicle must not exceed 1,100 lbs/sf; hand operated compactor or vibratory roller must not exceed a dynamic force of 20,000 lbs.
7. Transit or laser.
8. Stone bucket.

PLEASE NOTE THAT ALL PHOTOGRAPHS AND ILLUSTRATIONS ARE FOR ILLUSTRATIVE PURPOSES ONLY. PLEASE RELY ON WHAT THE ENGINEER SPECIFIES.

WHEN YOUR STORMCHAMBERS™ ARRIVE

1. Unloading – see “Before Your StormChambers™ Arrive”, above. As a last resort, the pallets can be dragged off of the trailer and dropped on the ground. This will not injure the StormChambers™.
2. Confirm the total number of StormChambers™ and contact HydroLogic Solutions immediately if the count is incorrect.
3. Confirm the number of Start, Middle and End StormChambers™. Each pallet should be marked with the number of each.

TRENCH PREPARATION

1. Do not excavate trench until dry weather is forecast long enough to allow at least coverage of the StormChamber™ system with filter fabric prior to raining to avoid soil filling void spaces in the stone.
2. Excavate to a width and length sufficient to accommodate the number of StormChambers™ plus a minimum one foot border around the entire bed. The bottom of the bed must be level, unless otherwise specified.
3. If the StormChamber™ system was designed for infiltration and heavy clays are encountered, it is recommended that pea gravel and sharp concrete sand be tilled into the top one foot of trench bed prior to placing the stone base.
4. Do not use heavy equipment on the excavated trench bed in order to avoid soil compaction.
5. If use of heavy equipment on the excavated trench bed can not be avoided, scarify the trench bottom and break up soil clumps before adding the stone base.
7. Unless otherwise specified, place 6” of crushed, washed, 1” to 2” hard stone on the bottom of the level and zero grade trench.
8. If it becomes impractical to level the stone base by hand, use a low pressure, tracked dozer, not exceeding 1,100 lbs/sf, maintaining at least 6” of stone under the tracks at all times.
9. Do not use excavated trench as a sedimentation trap or basin during construction. The fine soil particles will accumulate at the soil boundary and restrict the infiltration capability of the system.



Line trench walls, not trench bottom, with 4oz, non – woven filter fabric.

6. Line trench walls with a 4 – ounce non – woven filter fabric such as Mirafi 140N or 140NC, Synthetic Industries 401, or AMOCCO 4545 or 4535. Overlap adjacent filter fabric by at least 2’. Do not place filter fabric under the StormChambers™. The filter fabric will clog, restricting the infiltration capability of the StormChamber™ system.

STORMCHAMBER™ INSTALLATION



You may need to use 2x4's to separate chambers.

1. You may need assistance in separating the StormChambers™. Based on weather and transit conditions, sometimes the StormChambers™ become tightly compacted. Separate StormChambers™ using two 2x4 studs along one of its sides for leverage. Do not use any damaged units – contact HydroLogic Solutions immediately.



Row placement begins at inflow end of chamber system with Start Model StormChambers™.

2. Start building the StormChamber™ system with the Start Model StormChamber™ at the inflow end of the StormChamber™ system. The Start Models are completely closed at the end with the two side portals.



Place lightweight stabilization netting under StormChambers™.

3. Roll out two rows of the light weight stabilization netting (provided with the StormChambers™) perpendicular to the rows of where the Start StormChambers™ will be placed. Overlap the rows by approximately 1'. Keep the netting flat; if moved, re – straighten and flatten out.

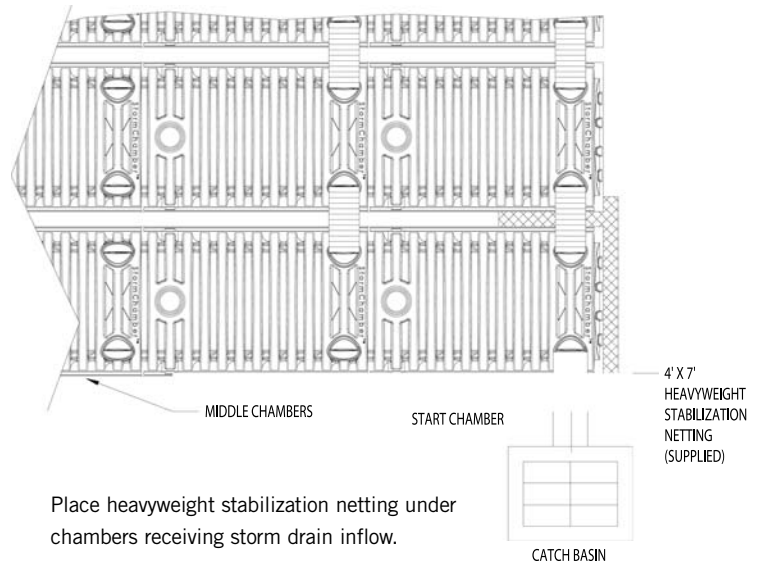

Place heavyweight stabilization netting under chambers receiving storm drain inflow.

4. Place one piece of the heavy weight stabilization netting (provided with the StormChambers™) perpendicular to and under each StormChamber™ that will be receiving inlet storm drain pipes. Place on top of the light weight netting and place one edge of the netting under, and slightly extending beyond, the closed end wall of the StormChamber™. Have the netting extend equally beyond both sides of the StormChamber™. The purpose of the heavy weight stabilization netting is to function as a “splash pan,” preventing excavation of the underlying stone and soil, while allowing infiltration to occur.

STORMCHAMBER™ INSTALLATION

(CONTINUED)

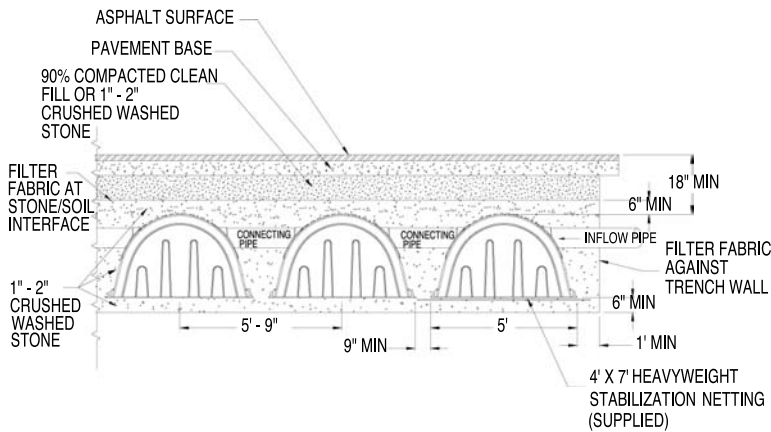

Space StormChambers™ at least 9" apart at the base at the end wall.

- Place the Start Model StormChambers™ (completely closed at the end with the two side portals), spaced a minimum of 5' 9" apart at the center line of the end walls (9" apart at the base at the end walls). Position the closed ends at least 1' from the trench wall.

Insert smooth wall PVC row connecting pipes.

- Mark the midpoints of 8" ID (unless otherwise specified) smooth wall pipe and insert into the adjacent StormChambers™ where specified so that the marked midpoint is centered between the two adjacent StormChambers™. Pipe length should be sufficient to extend 6" – 12" into both adjacent StormChambers™.



Cut out side portals for smooth wall PVC inflow drainpipe and row connecting pipes. Cut out indentation guides are provided for 8", 10" and 12" pipes.

- Cut open the side portals for the inflow storm drain pipes (size and location specified on the plans) and lateral connecting pipes between StormChamber™ rows (8" ID Schedule 40 or SDR 35 smooth walled PVC, unless otherwise specified) with a reciprocating saw, router bit on a drill, or keyhole saw along the defined indented circle. If the cut extends more than 0.5" beyond the indented circle, place a piece of the filter fabric over the hole, cut an X just short of the width of the opening, and insert the pipe. The connection does not need to be water tight. 12" ID smooth walled pipe is the largest diameter pipe that can be inserted into the side portals. In order to facilitate placement, install the lateral connecting pipes in the specified StormChambers™ before attaching the next StormChamber™ in the row.

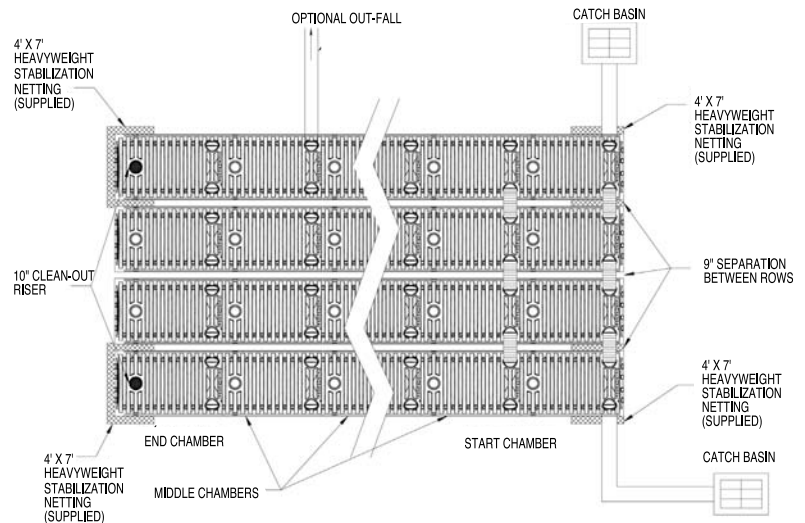

Example of typical StormChamber™ layout.

- If the locations of row – connecting pipes are not specified, add 8" pipes across all rows directly opposite where the inflow storm drain pipe(s) is inserted. This will typically connect at least all the Start Model StormChambers™ of each row. Additional connections across all rows of StormChambers™ should be made so that the total diameter of pipe connections between any pair of rows is approximately equal to the total diameter of all inflow storm drain pipes. For example, a StormChamber™ system with one 12" inflow drain pipe would require 2, 8" pipes between each row of StormChambers™.

STORMCHAMBER™ INSTALLATION

(CONTINUED)



Place first rib of next chamber over last rib of previous chamber.

- Roll out additional light weight stabilization netting, overlaying the previous sheet by 1' and place the first rib of a Middle Model (completely open at side portal end, partially open at top portal end) over the last rib of each of the Start Model StormChambers™.



Screw StormChamber™ together to prevent stone inflow.

- Screw the Middle Model StormChambers™ to the Start Models near their base on both sides with regular 3" dry wall screws. One screw on each side should be sufficient to temporarily hold the StormChambers™ together until the stone is placed. The gap between the two StormChambers™ near their base must be closed enough to prevent stone from migrating into them to prevent the potential for finished surface subsidence.



End each row with an end model StormChamber™ which is closed at the top portal end and open at the side portal end.

- Continue placing and screwing the rest of the StormChambers™, one at a time, as necessary, inserting any additional lateral – connecting pipes as specified, leaving at least 1' between the end of the End Model (completely open at the side portal end, completely closed at the top portal end) and the trench wall.

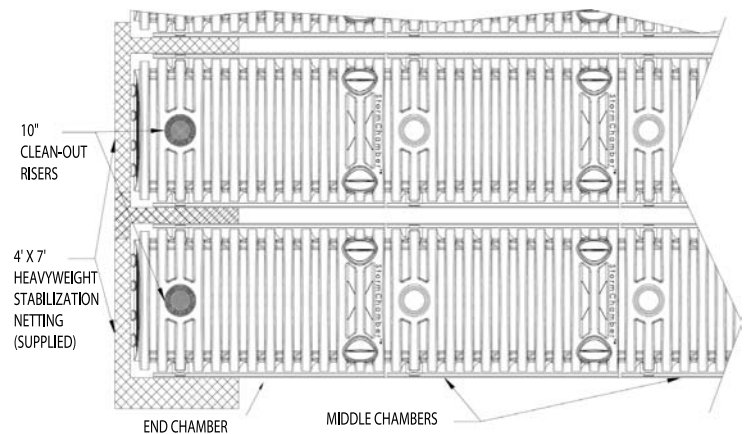

Place heavyweight stabilization netting under chambers with cleanout risers.

- Place one piece of the heavy duty stabilization netting under the top portal end of each StormChamber™ that will be installed with a 10" PVC riser for access by a vacuum truck for clean out. Extend the netting equally beyond both sides of the StormChamber™ and extend about 1' beyond the end wall of the StormChambers™. The purpose of the netting is to prevent the stone and soil from being sucked up by the vacuum truck.
- For large StormChamber™ systems it may be necessary to install and backfill a few Stormchambers™ of all rows at a time.

STORMCHAMBER™ INSTALLATION

(CONTINUED)

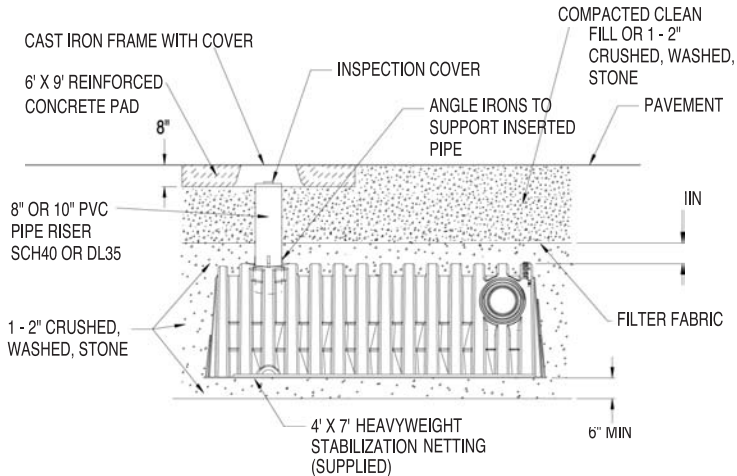

Install cleanout/inspection risers pipes.

14. Cut a hole in the top portal for a 10" ID smooth walled SDR 35 or PVC Schedule 40 riser – along the larger of the two indented circles, unless an 8" pipe is specified. If the cut extends more than 0.5" beyond the cut out, place a piece of the filter fabric over the hole, cut an X slightly shorter than the width of the opening, and insert the pipe. Attach three small angle irons equally spaced approximately 1' up from the end of the pipe. Use 0.5" screws on riser pipe to prevent restricting insert of vacuum truck clean out tube. It is not necessary to screw the angle irons to the StormChamber™. The purpose of the angle irons is simply to support the pipe until the backfill is placed. Insert the bottom 1' of pipe into the top portal and backfill. Attach top of riser pipe to a "Fernco Type" rubber cap, or to a cleanout cover assembly, as specified on the plans. Place an access casting in a concrete pad above, once all fill is placed, for risers in pavement.

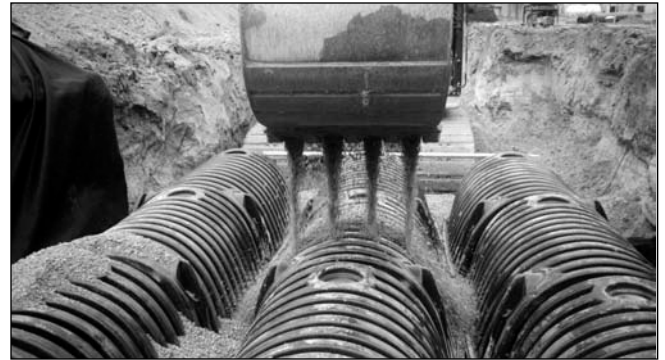

Deposit 1" – 2" crushed, washed, hard stone directly along the centerline of the StormChambers™.

15. Deposit 1" – 2" crushed, washed, hard stone directly along the centerline of the StormChambers™ to evenly flow down each side to keep the StormChambers™ in proper alignment. Do not place the stone directly against the closed end walls at the start and end of the rows. Let the stone fall in place at the StormChamber™ end from the top of the StormChamber™. Add stone to at least 6" above the StormChambers™.
16. Level the stone cover with a vibratory compactor, not to exceed a dynamic force of 10,000 lbs, or with a low pressure, tracked vehicle not exceeding 1,100 lbs/sf.

IMPORTANT: If low pressure, tracked dozer is used, do not run dozer on anything less than 6" of stone above the StormChambers™. Spread stone in small piles to prevent movement of the StormChambers™. Caution must be exercised when placing stone on top of the StormChambers™ so that excessive pressure is not applied directly on the StormChambers™ by equipment "buckets".

17. Cover the stone with 4 ounce non – woven filter fabric. Overlap adjacent sheets by at least 2'.

BACKFILLING

1. Backfill soil must be free from large stones and large organic material (e.g. tree limbs and root stumps), and must be capable of being compacted to at least 90% of the Standard Proctor Test (AASHTO Method T – 99). If not, crusher run or other suitable backfill material must be used. The same type of stone surrounding the StormChambers™ can also be extended up to the pavement sub grade, if desired.
2. Backfill and compaction of the soil backfill must be achieved in lifts 6" – 8" high. Grading of lifts should start in one corner of the system with a low pressure, tracked dozer, with a pressure not exceeding 1,100 lbs/sf, keeping at least 1' of fill in front of the blade at all times. Compact lifts to 90% Standard Proctor with tracked vehicles not exceeding 1,100 lbs/sf, or with a hand operated compactor or vibratory roller not exceeding a dynamic force of 20,000 lbs.
3. Restrict wheeled vehicles to a maximum axle load of

8,000 pounds with 6" of fill over the StormChambers™ and 16,000 pounds with 12" of fill.

4. Keep the StormChamber™ system closed or protected from receiving sediment until the site is completely stabilized.

IMPORTANT: After compaction of backfill and setting of final grade, avoid parking on or traversing over the StormChamber™ installation with heavily loaded trucks and heavy equipment until paved.

IMPORTANT: These instructions assume accepted construction procedures and loaded trucks that do not exceed specified DOT load limits. Uncustomary loads or improper load distributions in vehicles may require additional cover. Contact HydroLogic Solutions for installation under abnormal conditions. Installations not in compliance with these instructions will void the warranty.

Contact HydroLogic Solutions for technical assistance at 1.877.426.9128 or email us at info@hydrologicsolutions.com.

CONTACT INFORMATION

(877) 426-9126 (Toll-Free)

(703) 491-9656 (Fax)

(703) 492-0686 (Voice)

www.hydrologicsolutions.com

info@hydrologicsolutions.com (Email Us)

PO Box 672, Occoquan, Virginia 22125

HYDROLOGIC SOLUTIONS LIMITED WARRANTY

HydroLogic Solutions will warranty the structural integrity of each StormChamber unit in accordance with the installation instructions and is warranted to the original buyer against defective materials and workmanship for one year from the date of purchase. It is the responsibility of the buyer to inspect the StormChamber units prior to installation and to inform HydroLogic Solutions of any defect prior to installation. *HydroLogic Solutions will only be responsible for supplying replacement units. HydroLogic Solution's liability specifically excludes the cost of removal and/or installation of the units and shall not exceed the price or charge for its products.*

There are no other warranties with respect to the units, including no warranties of merchantability or fitness for a particular purpose. *This warranty does not extend to incidental, consequential, special or indirect damages. HydroLogic Solutions shall not be liable for penalties or liquidated damages, including loss of production and profits, labor and materials, overhead costs, or other loss or expenses incurred by the buyer.* Specifically, excluded from warranty coverage is damage to the units due to ordinary wear and tear, alteration, accident, misuse, abuse or neglect of the units, improper construction protocols, installation of the units not consistent with our installation

instructions, placement by the buyer of improper materials into the system, damage due to crushing by heavy equipment weighing in excess of what is listed in the installation instructions, failure to maintain the minimum ground covers as set forth in the installation instructions or any other event not caused by HydroLogic Solutions. *HydroLogic Solutions shall not be responsible for any loss or damage to the buyer, the units, or any third party resulting from its installation or shipment. The buyer shall be solely responsible for ensuring that the installation of the system is completed in according with the installation instructions, and will abide by all applicable laws, codes, rules and regulations.*

Inspection of shipment must occur within 5 days of receipt of StormChamber units and written notice of alleged defect must be provided in detail. Failure to advise us of defects within this allotted period will constitute acceptance of the shipment.

This warranty shall not apply to any party other than the original buyer. Furthermore, no Company representative or employee has the authority to modify or change this warranty in any manner, nor does this warranty apply to shipping or in transit damage.



The StormChamber™ is protected by the following U.S. Patents: 6,361,248; 6,612,777; 469,187; 465,545.
Canadian Patents: 2,356,592. Other U.S. and Canadian Patents Pending.

CONTACT INFORMATION

info@hydrologicsolutions.com (Email Us)
PO Box 672, Occoquan, Virginia 22125

(877) 426-9126 (Toll-Free)
(703) 492-0686 (Voice)

(703) 491-9656 (Fax)
www.hydrologicsolutions.com

HYDROLOGIC SOLUTIONS LIMITED WARRANTY

HydroLogic Solutions will warranty the structural integrity of each HydroLogic Solutions StormChamber™ in accordance with the installation instructions and is warranted to the original purchaser against defective materials and workmanship for 1 year from the date of purchase. It is the responsibility of the purchaser to inspect the StormChamber™ units prior to installation and to inform HydroLogic Solutions of any defect prior to installation. HydroLogic Solutions will only be responsible for supplying replacement StormChamber™ unit(s). HydroLogic Solutions' liability specifically excludes the cost of removal and/or installation of the units.

There are no other warranties with respect to the units, including no warranties of merchantability or fitness for a particular purpose. This warranty does not extend to incidental, consequential, special, or indirect damages. The company shall not be liable for penalties or liquidated damages, including loss of production and profits, labor and materials, overhead costs, or other loss or expense incurred by buyer. Specifically excluded from warranty coverage is damage to the units due to ordinary wear and tear, alter-

ation, accident, misuse, abuse or neglect of the units, improper construction protocols, installation of the units not consistent with HydroLogic Solutions' installation instructions, placement by buyer of improper materials into buyer's system, or any other event not caused by the company. HydroLogic Solutions shall not be responsible for any loss or damage to the buyer, the units, or any third party resulting from its installation or shipment. Buyer shall be solely responsible for ensuring that installation of the system is completed in accordance HydroLogic Solutions' installation instructions and with all applicable laws, codes, rules and regulations.

Inspect all shipment within 5 days of receipt of StormChambers™. Failure to advise HydroLogic Solutions of defects on shipments within this period will constitute acceptance of the shipment.

This warranty shall not apply to any party other than the original buyer. Furthermore, no company representative has the authority to modify or change this warranty in any manner.



The StormChamber™ is protected by the following U.S. Patents: 6,361,248; 6,612,777; 469,187; 465,545. Canadian Patents: 2,356,592. Other U.S. and Canadian Patents Pending.